



1200V 40A Field Stop Fast IGBT

(Integrated FRD)

1. Product Features:

- Ultra-low static losses
- Internal integrated fast&soft recovery anti-parallel FRD
- Maximum junction temperature 175°C
- 10µs short circuit Capability
- Qualified according to JEDEC
- RoHS compliant: Pb-Free including Lead plating and solder

2. Product Applications

- Solar String Inverter
- Uninterruptible Power Inverter Supplies (UPS)
- Welding

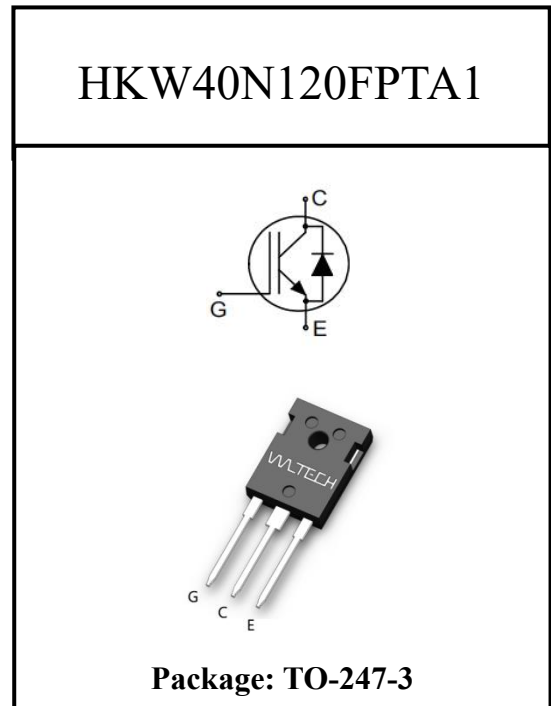

3. Typical Performance Parameters

Tab.1. Typical Performance Parameters

Type	V_{CE}	I_C	V_{CEsat} $T_{vj} = 25^\circ C$	T_{vjmax}	Marking	Package
HKW40N120FPTA1	1200V	40A	1.61V	175°C	HKW40N120FPTA1	TO-247-3

4. Maximum Ratings

Tab.2. Maximum Ratings

Parameters	Symbol	Value	Unit
Collector-emitter voltage	V_{CE}	1200	V
DC collector current (limited by T_{vjmax} and bond wire)	I_C	82.0 ($T_c = 25^\circ\text{C}$) 40.0 ($T_c = 120^\circ\text{C}$)	A
Pulsed collector current (t_p limited by T_{vjmax} .)	I_{Cpuls}	160.0	A
Turn off safe operating area ($V_{CE} \leq 1200\text{V}$, $T_{vj} \leq 175^\circ\text{C}$)	-	160.0	A
Diode forward current (limited by T_{vjmax})	I_F	58.0 ($T_c = 120^\circ\text{C}$)	A
Diode pulse current (t_p limited by T_{vjmax} .)	I_{Fpuls}	160.0 ($T_c = 25^\circ\text{C}$)	A
Gate-emitter voltage	V_{GE}	± 20	V
Power dissipation	P_{tot}	714.0 ($T_c = 25^\circ\text{C}$) 262.0 ($T_c = 120^\circ\text{C}$)	W
Operating junction temperature	T_{vj}	-40 to +175	$^\circ\text{C}$
Storage temperature	T_{stg}	-55 to +150	$^\circ\text{C}$
Short circuit withstand time ₁) $V_{GE} = 15\text{V}$, $V_{CC} \leq 600\text{V}$, $T_{j,start} \leq 150^\circ\text{C}$	t_{sc}	10	μs
Soldering temperature, (wave soldering 1.6mm from case for 10s)		260	$^\circ\text{C}$
Mounting torque (M3 screw) (Maximum of mounting processes: 3)	M	0.6	Nm

5. Thermal Properties

Tab.3. Thermal Properties

Parameters	Symbol	Max. value	Unit
IGBT thermal resistance (junction - case)	$R_{th(j-c)}$	0.21	$^\circ\text{C/W}$
Diode thermal resistance (junction - case)	$R_{th(j-c)}$	0.5	$^\circ\text{C/W}$
Thermal resistance (junction – ambient)	$R_{th(j-a)}$	40	$^\circ\text{C/W}$

6. Electrical Characteristics

Tab.4. Static Characteristic ($T_{vj} = 25^{\circ}\text{C}$, unless otherwise specified)

Parameters	Symbol	Conditions	Min. value	Typ. value	Max. value	Unit
Collector-emitter breakdown voltage	$V_{(BR)CES}$	$V_{GE} = 0\text{V}$, $I_C = 500\mu\text{A}$	1200	-	-	V
Collector-emitter saturation voltage	V_{CEsat}	$V_{GE} = 15\text{V}$, $I_C = 40\text{A}$ $T_{vj} = 25^{\circ}\text{C}$ $T_{vj} = 175^{\circ}\text{C}$	- -	1.61 2.13	2.00 -	V
Diode forward voltage	V_F	$V_{GE} = 0\text{V}$, $I_F = 40\text{A}$ $T_{vj} = 25^{\circ}\text{C}$ $T_{vj} = 175^{\circ}\text{C}$	- -	1.88 1.60	2.6 -	V
Gate-emitter threshold voltage	$V_{GE(th)}$	$I_C = 1.00\text{mA}$, $V_{CE} = V_{GE}$	5.1	5.92	6.8	V
Zero gate voltage collector current	I_{CES}	$V_{CE} = 1200\text{V}$, $V_{GE} = 0\text{V}$ $T_{vj} = 25^{\circ}\text{C}$ $T_{vj} = 175^{\circ}\text{C}$	- -	- -	250 2500	μA
Gate-emitter leakage current	I_{GES}	$V_{CE} = 0\text{V}$, $V_{GE} = 20\text{V}$	-	-	200	nA
Transconductance	g_{fs}	$V_{CE} = 20\text{V}$, $I_C = 40.0\text{A}$	-	23.0	-	S

Tab.5. Dynamic Characteristic ($T_{vj} = 25^{\circ}\text{C}$, unless otherwise specified)

Parameters	Symbol	Conditions	Min. value	Typ. value	Max. value	Unit
Input capacitance	C_{ies}	$V_{CE} = 25\text{V}$, $V_{GE} = 0\text{V}$ $f = 1\text{MHz}$	-	8750	-	pF
Output capacitance	C_{oes}		-	216	-	
Reverse transfer capacitance	C_{res}		-	64	-	
Gate-charge	Q_g	$V_{CE} = 960\text{V}$, $I_C = 40.0\text{A}$, $V_{GE} = 15\text{V}$	-	296	-	nC

Tab.6. Switching Characteristic (Inductive load)

Parameters	Symbol	Conditions	Min. value	Typ. value	Max. value	Unit
IGBT Characteristic, at $T_{vj} = 25^{\circ}\text{C}$						
Turn-on delay time	$t_{d(on)}$	$T_{vj} = 25^{\circ}\text{C}$, $V_{CC} = 600\text{V}$, $I_C = 40.0\text{A}$, $V_{GE} = 0.0/15.0\text{V}$, $R_G = 10.0\Omega$ Inductive load	-	68	-	ns
Rise time	t_r		-	55	-	
Turn-off delay time	$t_{d(off)}$		-	274	-	
Fall time	t_f		-	250	-	
Turn-on energy	E_{on}	Energy losses include "tail" and diode reverse recovery.	-	2.92	-	mJ
Turn-off energy	E_{off}		-	2.84	-	
Total switching energy	E_{ts}		-	5.76	-	
Diode Characteristic, at $T_{vj} = 25^{\circ}\text{C}$						
Diode reverse recovery time	t_{rr}	$T_{vj} = 25^{\circ}\text{C}$, $V_R = 600\text{V}$, $I_F = 40.0\text{A}$, $di_F/dt = 500\text{A}/\mu\text{s}$	-	390	-	ns
Diode reverse recovery charge	Q_{rr}		-	3.14	-	μC
Diode peak reverse recovery current	I_{rrm}		-	21	-	A
Diode peak rate of fall of reverse Recovery current during tb	di_{rr}/dt		-	-268	-	A/ μs

Tab.7. Switching Characteristic (Inductive load)

Parameters	Symbol	Conditions	Min. value	Typ. value	Max. value	Unit
IGBT Characteristic, at $T_{vj} = 175^{\circ}\text{C}$						
Turn-on delay time	$t_{d(on)}$	$T_{vj} = 175^{\circ}\text{C}$, $V_{CC} = 600\text{V}$, $I_C = 40.0\text{A}$, $V_{GE} = 0.0/15.0\text{V}$, $R_G = 10.0\Omega$, Inductive load	-	63	-	ns
Rise time	t_r		-	65	-	
Turn-off delay time	$t_{d(off)}$		-	309	-	
Fall time	t_f		-	432	-	
Turn-on energy	E_{on}	Energy losses include "tail" and diode reverse recovery.	-	4.17	-	mJ
Turn-off energy	E_{off}		-	4.09	-	
Total switching energy	E_{ts}		-	8.25	-	
Diode Characteristic, at $T_{vj} = 175^{\circ}\text{C}$						
Diode reverse recovery time	t_{rr}	$T_{vj} = 175^{\circ}\text{C}$, $V_R = 600\text{V}$, $I_F = 40.0\text{A}$, $di_F/dt = 500\text{A}/\mu\text{s}$	-	715	-	ns
Diode reverse recovery charge	Q_{rr}		-	10.3	-	μC
Diode peak reverse recovery current	I_{rrm}		-	41	-	A
Diode peak rate of fall of reverse Recovery current during tb	di_{rr}/dt		-	-464	-	$\text{A}/\mu\text{s}$

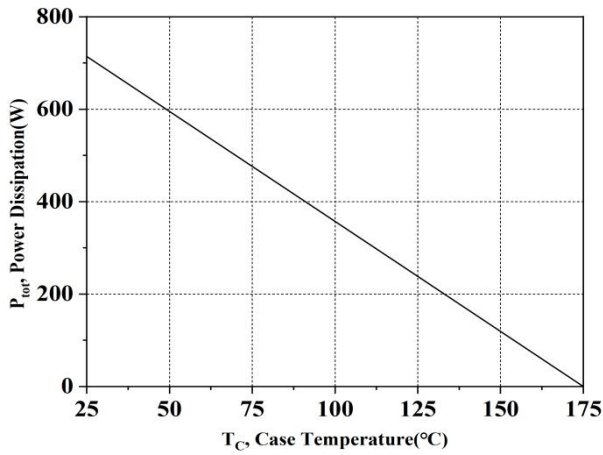

Fig.1. Power dissipation as a function of case temperature ($T_j \leq 175^\circ\text{C}$)

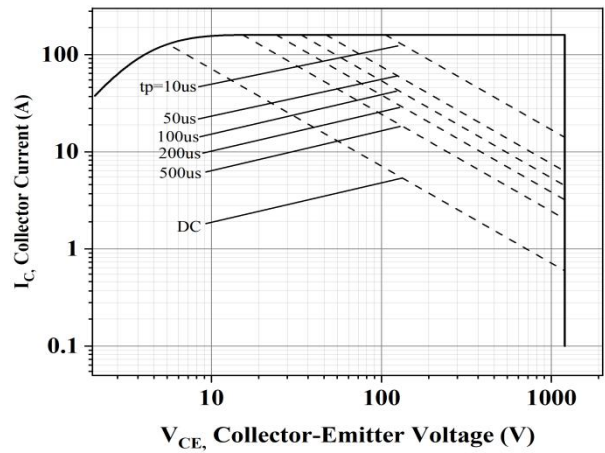

Fig.2. Forward bias safe operating area ($D = 0, T_C = 25^\circ\text{C}, T_j \leq 175^\circ\text{C}, V_{GE} = 15\text{V}$)

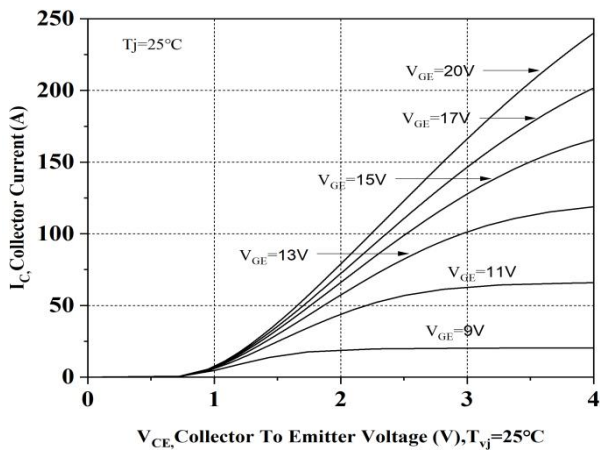

Fig.3. Typical output characteristics ($T_j = 25^\circ\text{C}$)

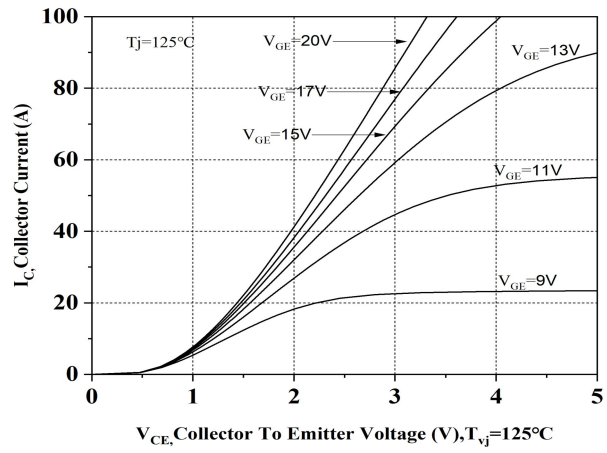

Fig.4. Typical output characteristics ($T_j = 175^\circ\text{C}$)

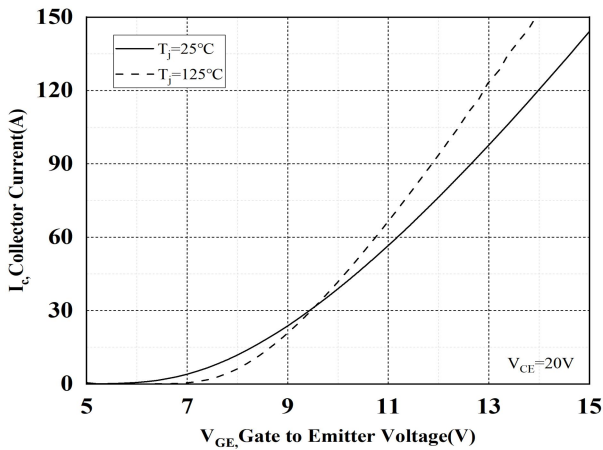

Fig.5. Typical transfer characteristic

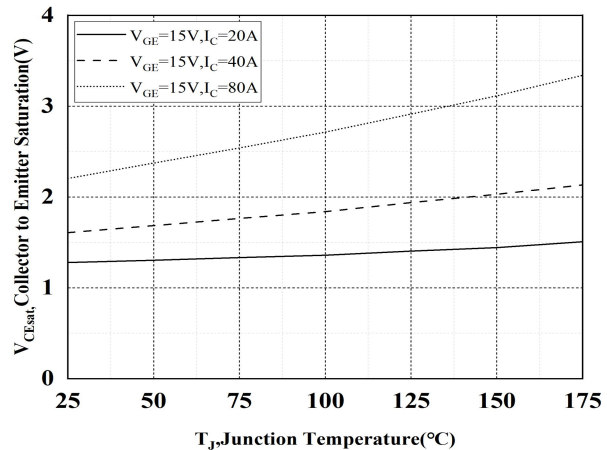

Fig.6. Typical collector-emitter saturation voltage as junction temperature

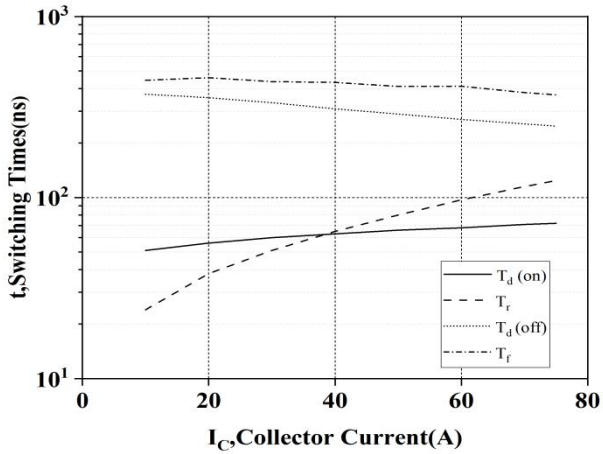

Fig.7. Typical switching times as collector current
($T_j = 175^\circ\text{C}$, $V_{CE} = 600\text{V}$, $V_{GE} = 15/0\text{V}$)

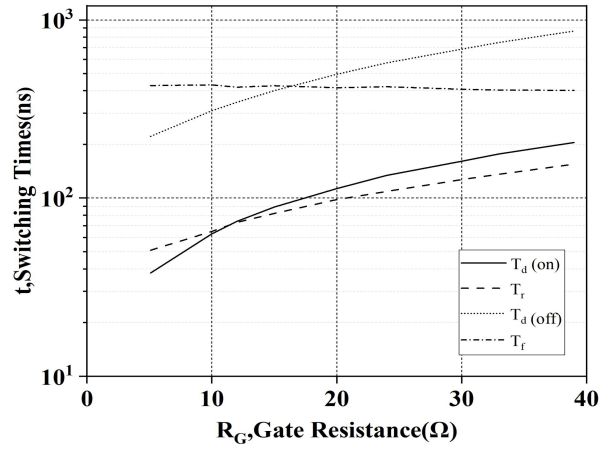

Fig.8. Typical switching times as gate Resistor
($T_j = 175^\circ\text{C}$, $V_{CE} = 600\text{V}$, $V_{GE} = 15/0\text{V}$, $I_C = 40\text{A}$)

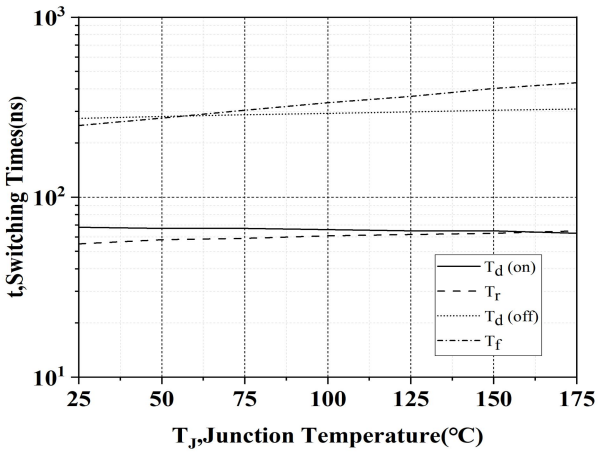

Fig.9. Typical switching times as junction temperature
($V_{CE} = 600\text{V}$, $V_{GE} = 15/0\text{V}$, $I_C = 40\text{A}$)

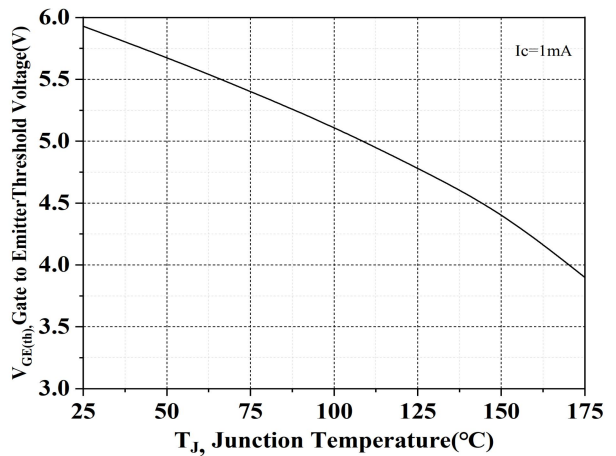

Fig.10. Gate-emitter threshold voltage as junction temperature

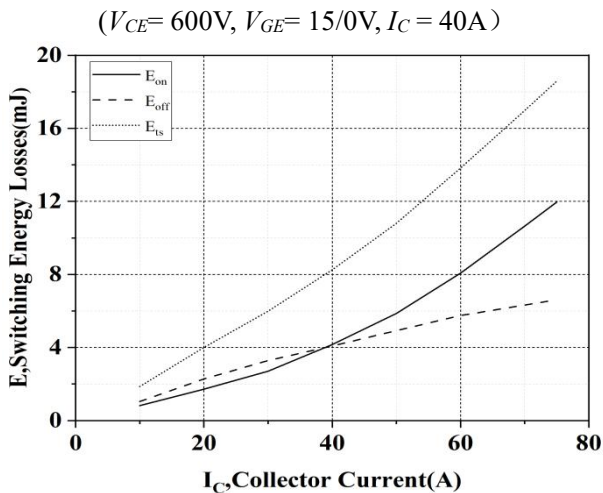

Fig.11. Typical switching energy losses as a function of collector current
($T_j = 175^\circ\text{C}$, $V_{CE} = 600\text{V}$, $V_{GE} = 15/0\text{V}$)

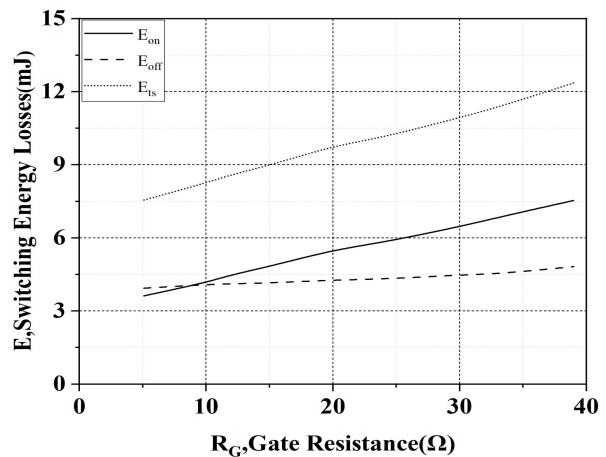

Fig.12. Typical switching energy losses as a function of gate resistor
($T_j = 175^\circ\text{C}$, $V_{CE} = 600\text{V}$, $V_{GE} = 15/0\text{V}$, $I_C = 40\text{A}$)

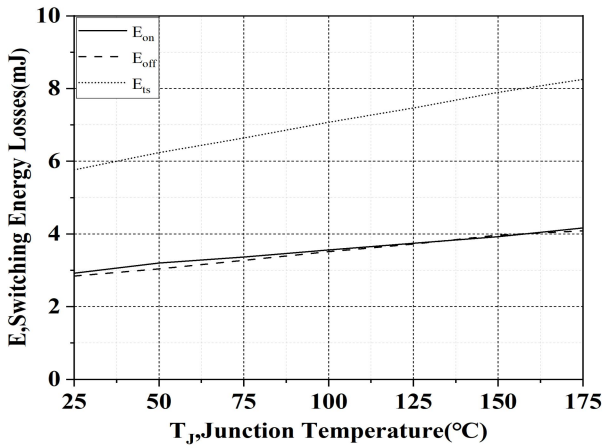

Fig.13. Typical switching energy losses as a function of junction temperature

(Inductive load, $V_{CE} = 600V$, $V_{GE} = 15/0V$, $I_C = 40A$)

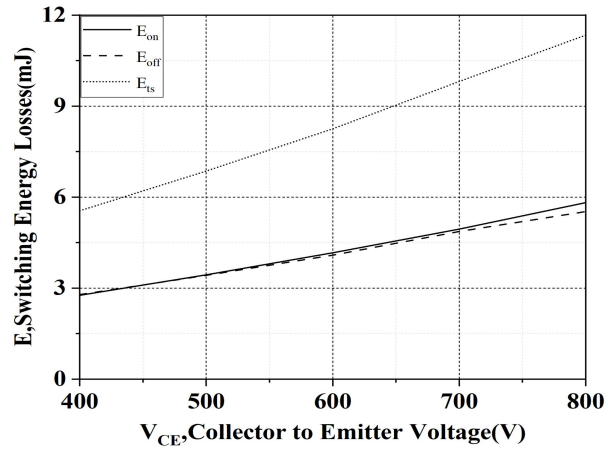

Fig.14. Typical switching energy losses as a function of collector emitter voltage

(Inductive load, $T_j = 175^\circ C$, $V_{GE} = 15/0V$, $I_C = 40A$)

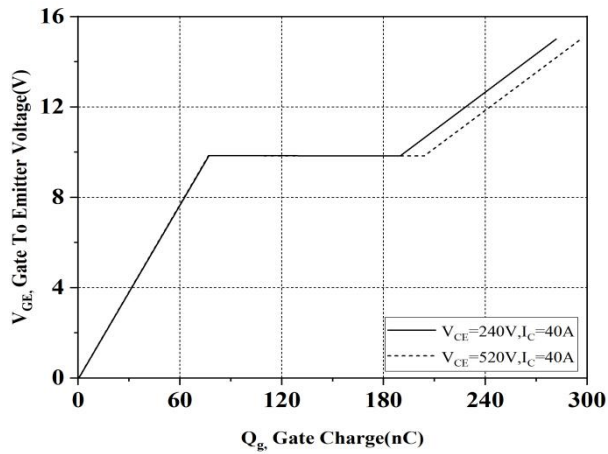

Fig.15. Typical gate charge

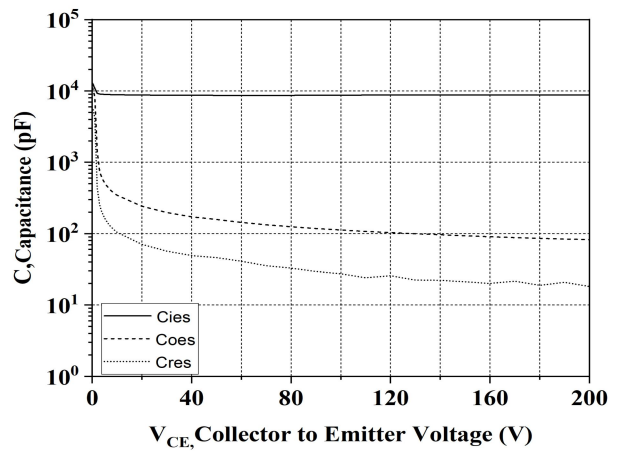

Fig.16. Typical capacitance as a function of collector-emitter voltage
($V_{GE} = 0V$, $f = 1MHz$)

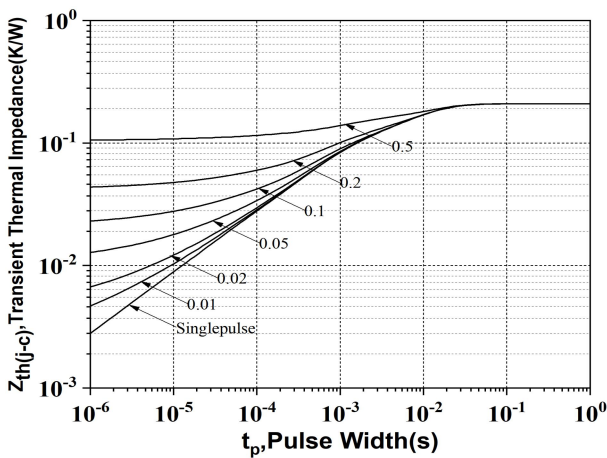

Fig.17. IGBT transient thermal impedance
($D = t_p/T$)

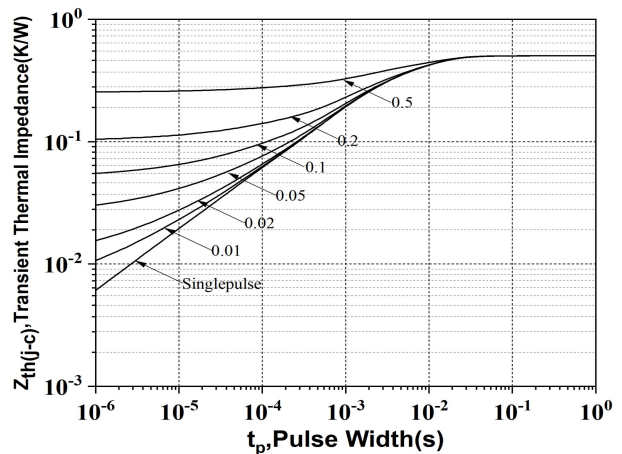

Fig.18. Transient thermal impedance of diode
($D = t_p/T$)

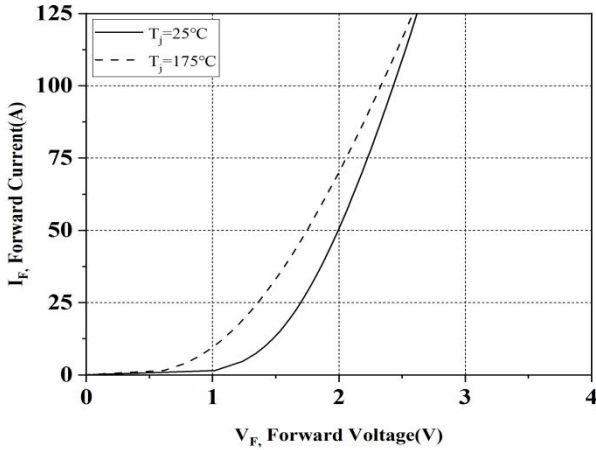

Fig.19. Typical diode forward current as a function of forward voltage

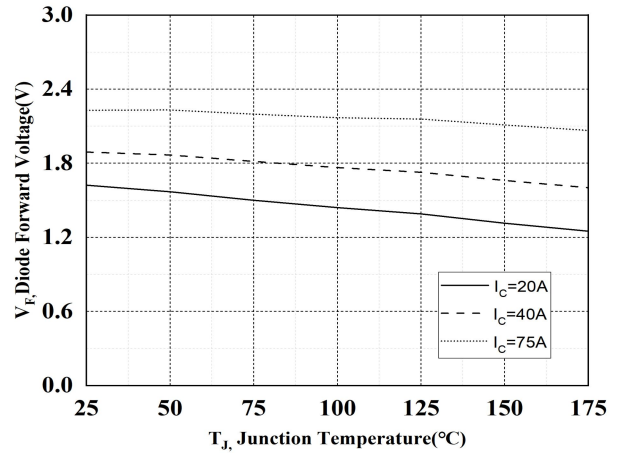

Fig.20. Typical diode forward voltage as a function of junction temperature

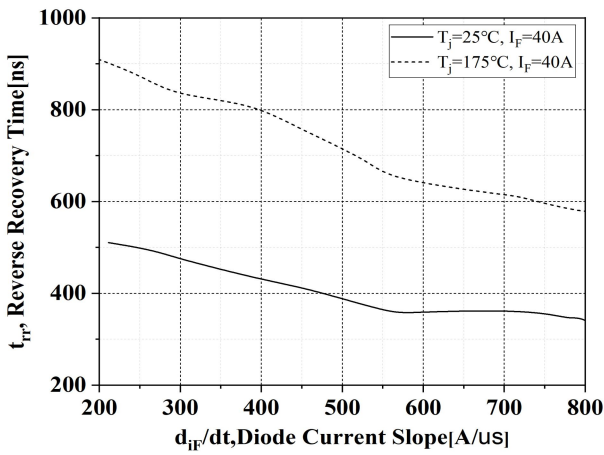

Fig.21. Typical reverse recovery time as a function of diode current slope (VR=600V)

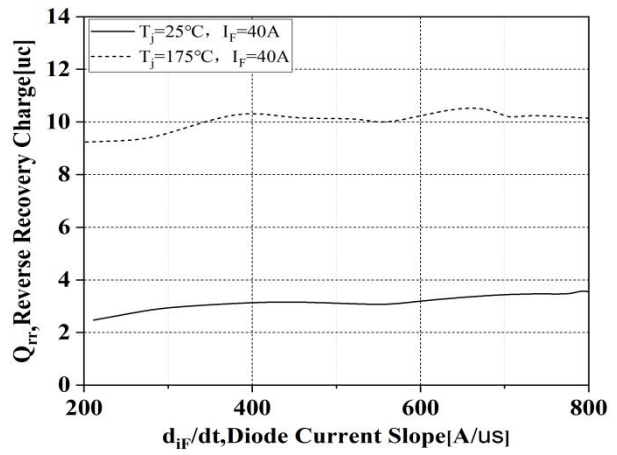

Fig.22. Typical reverse recovery charge as a function of diode current slope (VR=600V)

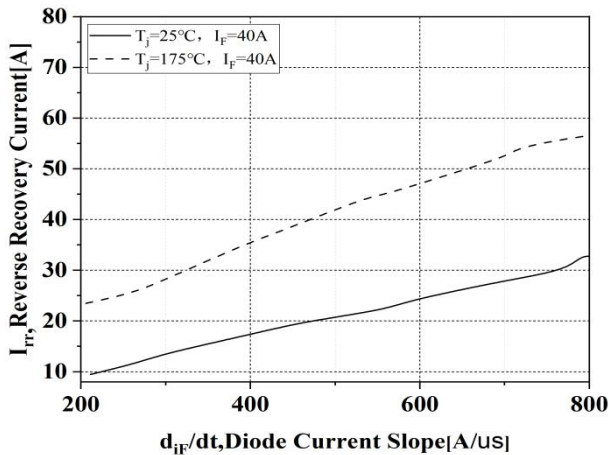

Fig.23. Typical reverse recovery current as a function of diode current slope (VR=600V)

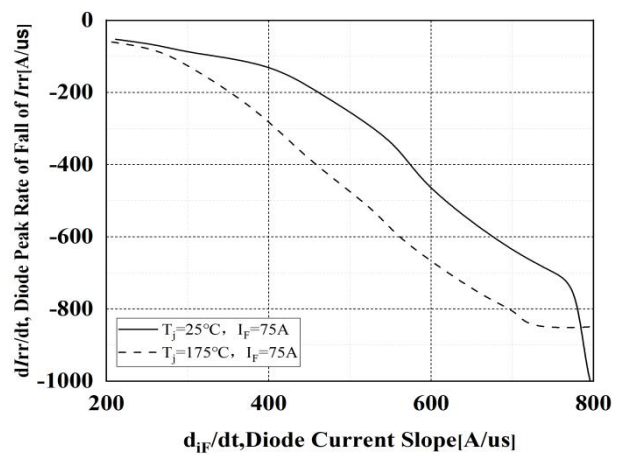
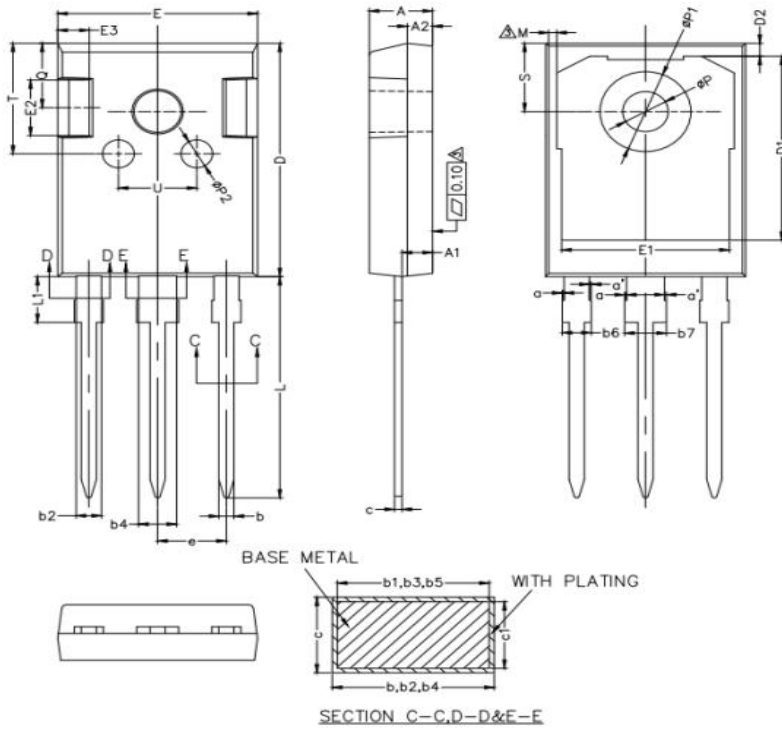

Fig.24. Typical diode peak rate of fall of reverse recovery current as a function of diode current slope (VR=600V)

7. Package Dimensions



COMMON DIMENSIONS
(UNITS OF MEASURE=MILLIMETER)

SYMBOL	MIN	NOM	MAX
A	4.90	5.00	5.10
A1	2.31	2.41	2.51
A2	1.90	2.00	2.10
a	0	—	0.15
a'	0	—	0.15
b	1.16	—	1.26
b1	1.15	1.2	1.22
b2	1.96	—	2.06
b3	1.95	2.00	2.02
b4	2.96	—	3.06
b5	2.95	3.00	3.02
b6	—	—	2.25
b7	—	—	3.25
c	0.59	—	0.66
c1	0.58	0.60	0.62
D	20.90	21.00	21.10
D1	16.25	16.55	16.85
D2	1.05	1.20	1.35
E	15.70	15.80	15.90
E1	13.10	13.30	13.50
E2	4.90	5.00	5.10
E3	2.40	2.50	2.60
e	5.34	5.44	5.54
L	19.80	19.92	20.10
L1	3.95	4.13	4.30
M	0.35	—	0.95
P	3.50	3.60	3.70
P1	7.00	—	7.40
P2	2.40	2.50	2.60
Q	5.60	—	6.00
S	6.05	6.15	6.25
T	9.80	—	10.20
U	6.00	—	6.40

NOTES:
1. ALL DIMENSIONS REFER TO JEDEC STANDARD
TO-247 AD DO NOT INCLUDE MOLD FLASH
OR PROTRUSIONS.
2. EJECTION MARK DEPTH 0.10±0.15

8. Version Information

Version No.	Date changed	Version revision record
V1.0	2023/12	Release